

Bissell®

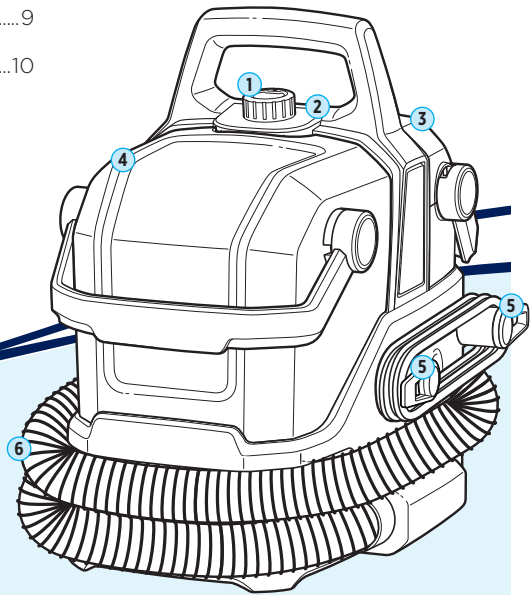















SPOTCLEAN® HYDROSTEAM™ PORTABLE CARPET AND UPHOLSTERY CLEANER MODELS 3700E & 3689E











What's in the Box?	4
Assembly (select models).....	4
Filling the Formula Tank.....	5
Stain, Surface, and Tool Guide.....	6
Using Your Machine.....	7
Emptying the Dirty Water Tank.....	8
Cleaning and Storing Your Machine	8
Thermal Protector.....	9
Troubleshooting.....	9
Limited Warranty.....	10



Product Overview

1. Power and Cleaning Mode Dial
2. Steam Ready Light
3. Clean Water Tank
4. Dirty Water Tank
5. Quick Release™ Cord Wrap and Power Cord
6. Flexible Hose

SYMBOL	EXPLANATION
	Caution.
	Read operator's manual.
	Risk of fire.
	Risk of electric shock.
	Do not expose to rain.
	Store indoors.
	Do not overwet carpet. Use only on carpet moistened by the cleaning process.
	Use only BISSELL® cleaning formulas intended for use with this machine.
	Disconnect power before servicing.
	Caution, hot surface.
	Warning: Slippery surface.
	Allow parts to dry.
	Use warm water, temperature up to 60°C.
	Lock.
	Do not freeze.

SYMBOL	EXPLANATION
	Check the manufacturer's tag before cleaning textile. "W" on the tag as shown means you can use your cleaner.
	This symbol on the product and/or accompanying documents means that used electrical and electronic products should not be mixed with general household waste. For proper treatment, recovery and recycling, please take this product to designated collection points. Please contact your local authority for further details of your nearest designated collection point.
	Steam ready in 30 seconds.
	WARNING: Danger of scalding. Steam.
	Combination of steam and fluid.
	Fluid.
	Area Rug. Small area rug cleaning mode.
	Upholstery.
	Curtains.
	Cleaning tile and grout.
	Cleaning sneakers.

IMPORTANT SAFETY INSTRUCTIONS

READ ALL INSTRUCTIONS BEFORE USING YOUR APPLIANCE.

When using an electrical appliance, basic precautions should be observed, including the following:



WARNING

TO REDUCE THE RISK OF FIRE, ELECTRIC SHOCK OR INJURY:

- This appliance can be used by children aged from 8 years and above and persons with reduced physical, sensory or mental capabilities or lack of experience and knowledge if they have been given supervision or instruction concerning use of the appliance in a safe way and understand the hazards involved. Children shall not play with the appliance. Cleaning and user maintenance shall not be made by children without supervision.
- This appliance is not intended for use by persons (including children) with reduced physical, sensory or mental capabilities, or lack of experience and knowledge, unless they have been given supervision or instruction concerning use of the appliance by a person responsible for their safety.
- Children should be supervised to ensure that they do not play with the appliance.
- Keep hair, loose clothing, fingers, and all parts of body away from openings and moving parts of the appliance and its accessories.
- The appliance has to be unplugged after use and before carrying out user maintenance on the appliance.
- If the supply cable is damaged, it must be replaced by the manufacturer, its service agent or similarly qualified person in order to avoid a hazard.
- Do not leave appliance when it is plugged in. Unplug from outlet when not in use and before servicing.
- Do not pull or carry by cable, use cable as a handle, close door on cable, or pull cable around sharp edges or corners. Do not run appliance over cable. Keep cord away from heated surfaces.
- Do not unplug by pulling on cable. To unplug, grasp the plug, not the cable.
- Do not handle plug or appliance with wet hands.
- Turn OFF all controls before plugging or unplugging appliance.
- Plastic film can be dangerous. To avoid danger of suffocation, keep away from children.
- Do not use for any purpose other than described in this user guide. Use only manufacturer's recommended attachments.
- If appliance is not working as it should, has been dropped, damaged, left outdoors, or dropped into water; do not attempt to operate it and have it repaired at an authorized service center.
- Do not put any object into openings. Do not use with any opening blocked; keep openings free of dust, lint, hair, and anything that may reduce air flow.
- Use extra care when cleaning on stairs.
- Do not use to pick up flammable or combustible materials (lighter fluid, gasoline, kerosene, etc.) or use in areas where they may be present.
- Do not pick up toxic material (chlorine bleach, ammonia, drain cleaner, etc.)
- Do not use appliance in an enclosed space filled with vapors given off by oil-based paint, paint thinner, some moth-proofing substances, flammable dust, or other explosive or toxic vapors.
- Keep appliance on a level surface.
- Do not pick up anything that is burning or smoking, such as cigarettes, matches, or hot ashes.
- Do not expose to rain. Store indoors.
- Always connect to a properly earthed electrical socket. Do not modify earthed plug.
- Liquid must not be directed toward equipment containing electrical components.
- Use only the type and amount of liquids specified under the operations section of this guide.
- Always install float before any wet pick-up operation.
- Do not turn your appliance ON until you are familiar with all instructions and operating procedures.
- Steam must not be directed toward people, animals, or equipment containing electrical components, such as interior of ovens.
- Do not use on leather, wax polished furniture or floors, synthetic fabrics, velvet or other delicate, steam-sensitive materials.
- The appliance is not to be used if it has been dropped, if there are visible signs of damage or if it is leaking.
- Keep the appliance out of reach of children when it is energized or cooling down.
- Do not leave the appliance unattended while it is connected to the supply mains.
- Floor slippery when wet.
- Do not open the filling aperture during use.
- If your appliance is fitted with a nonrewireable BS 1363 plug it must not be used unless a 13 amp (ASTA approved to BS 1362) fuse is fitted in the carrier contained in the plug. Spares may be obtained from your BISSELL supplier. If for any reason the plug is cut off, it must be disposed of, as it is an electric shock hazard should it be inserted into a 13 amp socket.

SAVE THESE INSTRUCTIONS

ORIGINAL INSTRUCTIONS.

FOR OPERATION ON A 220-240 VOLT A.C. 50-60 HZ POWER SUPPLY ONLY.



THIS MODEL IS FOR HOUSEHOLD USE ONLY.

IMPORTANT INFORMATION

- To reduce the risk of a leaking condition, do not store where freezing may occur. Damage to internal components may result.
- Keep appliance on a level surface.
- Plastic tanks are not dishwasher safe. Do not put tanks in dishwasher.

What's in the Box?

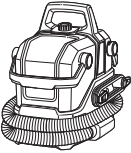
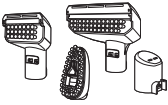
Standard accessories may vary by model. To identify what should be included with your purchase, please refer to the "Carton Contents" list located on the carton top flap.

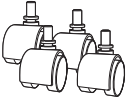
			
Machine	Tools (vary by model)	Formula(s) (vary by model)	Wheels (select models)

Assembly (select models)

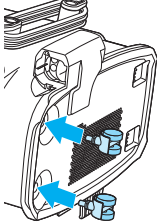
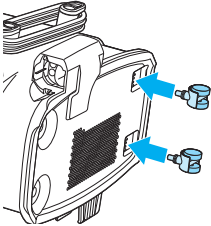
	
1. Remove tanks and tilt machine on its side. Firmly insert wheels into recessed holes in base of machine.	2. Wheels on clean tank side must be aligned with recessed area.

Filling the Formula Tank

Find more formulas at global.BISSELL.com.



This machine is compatible with BISSELL® formulas made for portable carpet cleaners. Always use genuine BISSELL formulas in your machine. Use of other cleaning formulas may harm the machine.

<p>1. Choose your formula.* Visit global.bissell.com for formulas.</p>	<p>2. Remove clean water tank from back of machine by lifting carry handle.</p>	<p>3. Flip cap open.</p>
<p>4. Add water to line based on size of your mess.</p> <p>Small Area: 825 mL Large Area: 1.65 L</p>	<p>5. Add formula** to line based on size of your mess.</p> <p>Small Area: 120 mL Large Area: 235 mL</p>	<p>6. Close cap. Return clean tank to machine and click back into place.</p>

*Compatible BISSELL formulas include: Spot & Stain, PRO OXY Spot & Stain, PET Spot & Stain, PET PRO OXY Spot & Stain, SIMPLY
**Machine may be used without formula; however, BISSELL recommends using only distilled water to prevent hard water buildup and prolong the life of your machine.

Stain, Surface, and Tool Guide

➤ To purchase additional tools or formulas, visit global.bissell.com.



3" Tool

Great for hard-to-reach areas and small stains.





5" Tool

Wider clean path for upholstery, curtains, car interiors, stairs, and larger stains.



Multi-Surface Tool

Clean unique areas like tile and grout, sneakers, car consoles, and more.

Cleaning Mode	 SteamWash™ Max Clean Mode	 Steam Mode	 Wash Mode
Cleaning Method	Spray + Steam	Steam	Spray
Description	HydroSteam™ and formula penetrate the toughest messes for fast and effective stain removal.	Loosen stains and refresh carpets and upholstery.	Water and formula scrub away everyday dirt and stains.
Recommended Tools	3", 5"	5", Multi-Surface Tool	3", 5"
Recommended Surfaces	Carpet, Area Rugs, Upholstery	Tile/Grout, Drapes, Upholstery	Carpet, Area Rugs
Beverages: Coffee, Cola, Fruit Juice, Red Wine, Tea	✓	✓	
Oily Messes: Cooking Grease, Pasta Sauce	✓	✓	
Sticky Messes: Chocolate Syrup, Honey, Jelly	✓		
Pet: Vomit, Blood, Grass, Dirt, Urine, Feces			✓
Dairy: Milk, Yogurt, Baby Formula			✓

⚠ WARNING To reduce the risk of fire and electric shock due to internal component damage, use only BISSELL cleaning formula intended for use with this machine.

Using Your Machine



Note: This appliance is primarily a portable carpet cleaner with a steam-cleaning attachment.

Before you clean, vacuum to remove loose dirt from areas to be cleaned. Spray any BISSELL stain pretreat formula on soiled areas and allow to sit for a few minutes. Test a small, hidden area for colorfastness and examine when dry. If color is affected, do not use.

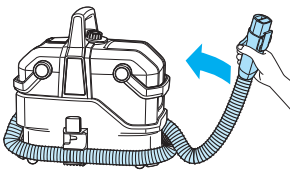
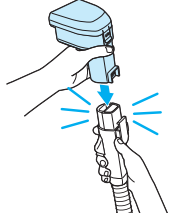
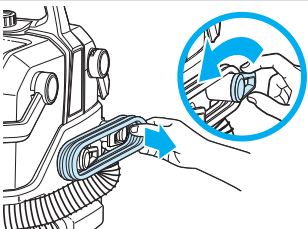
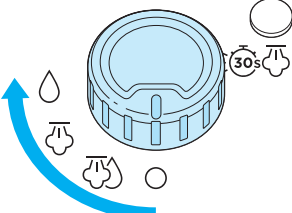
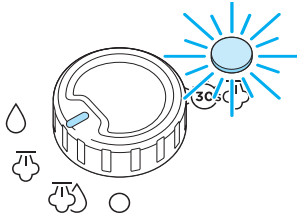
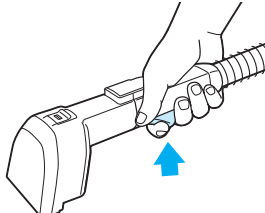
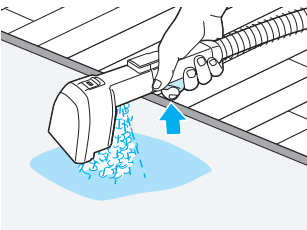
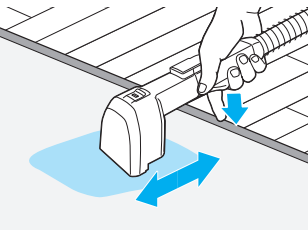
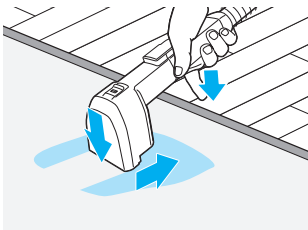
		
<p>1. Release hose by pulling away from hose clip.</p>	<p>2. Attach desired tool to hose grip until it clicks.</p>	<p>3. Twist Quick Release™ Cord Wrap to remove cord. Plug cord into outlet.</p>
		
<p>4. Select cleaning mode to turn machine ON. Turn dial to (O) position to turn OFF.</p>	<p>5. If choosing a mode with steam, wait 30 seconds for steam light to illuminate.</p>	<p>6. Press and hold trigger over sink or bowl to prime the machine until steam is present.</p>
		
<p>7. Point tool above stain. Firmly press and hold trigger.</p>	<p>8. Release trigger and use bristles to scrub area.</p>	<p>9. To remove stain, release trigger and make “dry passes”. Firmly apply downward pressure and move tool slowly toward you until water can no longer be seen in nozzle.</p>

Note: In **Steam Mode** or **SteamWash™ Max Clean Mode**, it is normal for some liquid to dispense during initial steam usage and after longer durations without using steam. The longer the trigger is pressed down, the more consistent the steam is. During periods without using steam, excess water may build up and dispense upon holding the trigger again. During these instances, continue to hold the trigger for 5-10 seconds until steam comes out.

Emptying the Dirty Water Tank

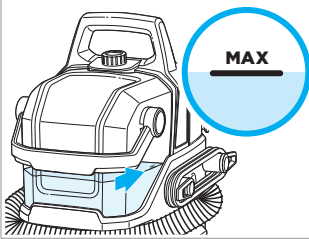

1. Empty dirty water tank when water reaches "MAX" line. **Do not let water overflow.**

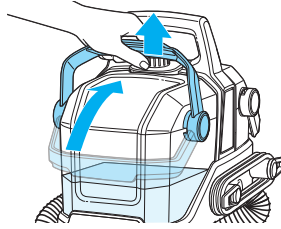

2. Remove dirty water tank and carry to a disposal area.

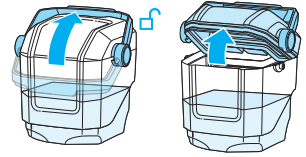

3. Holding dirty tank from bottom, unlock and remove lid by rotating handle backward.

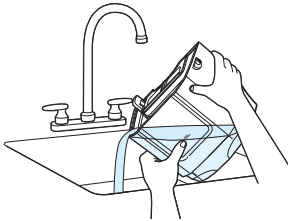

4. Pour out dirty water. Rinse out tank to remove any debris.

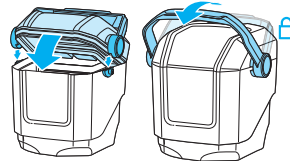

5. Align lid and rotate handle forward to lock into place.

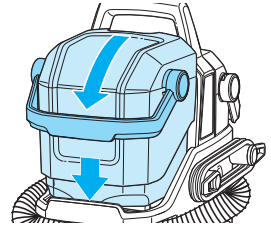

6. Place dirty water tank back onto machine.

Cleaning and Storing Your Machine

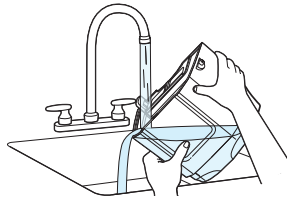

1. Be sure to empty dirty water tank after use (see above).

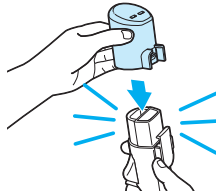

2. Clean hose with **HydroRinse™ Self-Cleaning Hose Tool**: Attach tool to end of hose grip until it clicks.

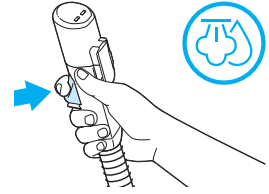

Turn dial to **SteamWash™ Max Clean Mode**. With hose upright and machine ON, press HydroRinse trigger 30 seconds.



Hose Cleaning Alternative: Suction clean water from bowl (or bucket). Lift and stretch hose until all water is cleared. Do not suction >94 L water.

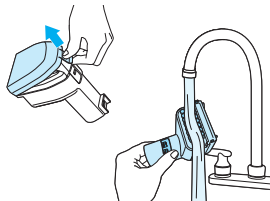

3. Power OFF and unplug machine. Lift latch on clear nozzle to remove. Rinse and wipe away any debris from steam nozzle.

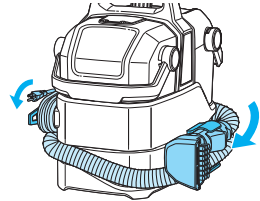

4. Wrap hose for storage. Store indoors in a secure, dry location.

Thermal Protector

An internal thermal protector has been designed into your vacuum to protect it from overheating. When the thermal protector activates, the main vacuum motor will stop operating. If this happens, proceed as follows:

1. Turn vacuum OFF and unplug from electrical outlet.
2. Let the motor cool for approximately 30 minutes. The thermal protector will automatically reset, and cleaning may continue once plugged back in.

Note: If the thermal protector continues to activate after following the above steps, your cleaner may need servicing. Call BISSELL® Consumer Care or visit the website.

Note: Any other servicing should be performed by an authorized service representative.

Troubleshooting

🔍 Below are some of the issues you may run into. If you don't see the issue you're experiencing below, visit global.bissell.com.

Problem	Possible Cause	Remedies
Reduced/no spray	Clean water tank may be empty.	Refill tank.
	Clean water tank may not be seated properly.	Fully seat tank until it clicks into place.
	Spray tip may be clogged/dirty.	Clean spray tip.
Reduced/loss of suction	Dirty tank may be full.	Empty dirty tank.
	Red filter under dirty tank may be clogged.	Remove any debris from the red filter.
	Dirty tank may not be correctly seated.	Ensure there are no obstructions preventing the dirty tank from fully being seated in its recess.
	Dirty tank lid may not be correctly seated.	Ensure the lid is fully seated in the dirty tank and the handle fully locks the lid into place.
	Tool or hose may be clogged with hair/fibers/etc.	Remove any clogs.
Machine leaks	<i>From bottom:</i> Dirty tank has been filled beyond the "MAX" line with water or foam.	Do not allow machine to collect liquid past the "MAX" line. Ensure only BISSELL portable deep cleaner formulas are used, at the correct concentrations, to prevent excessive foaming.
	<i>From hose/tool:</i> Water remains in hose after turning off.	Run machine for several seconds after stopping suction to ensure water is sucked into dirty tank.
No/low steam	Clean water tank may be empty.	Refill tank.
	Machine not pre-heated.	Wait 30 seconds for "steam ready" indicator light to turn on.
	Water sprays instead of steam.	This is normal; a small amount of water condensate forms in the steam lines when steam is not used. Continue to hold the trigger and steam will come out within 5-10 seconds.
Steam ready light not illuminated after two minutes	Thermal protector on heater has tripped.	Please visit an authorized service center.

Limited Warranty

This limited warranty only applies outside of the USA, Canada, Australia, New Zealand, and mainland China. It is provided by BISSELL International Trading Company B.V. ("BISSELL") and gives you specific rights. It is offered as an additional benefit to your other rights under your local laws, which may vary from country to country. You can find out about your legal rights and remedies by contacting your local consumer advice service. Nothing in this warranty will replace or lessen any of your legal rights or remedies. If you need additional instruction regarding this warranty or have questions regarding what it may cover, please contact BISSELL Consumer Care or contact your local distributor.

This warranty is given to the current owner of the product with the original sales receipt. The original sales receipt must include the product(s) purchased, the date purchased, and which country it was purchased from new. You must be able to evidence the date of purchase and the country where the product was purchased to submit a claim under this warranty. You will receive the warranty that is applicable to the country where your product was originally purchased, as shown on the original sales receipt. If you use the product outside of the country where it was purchased, your warranty may be void in BISSELL's sole discretion. It may be necessary to obtain some of your personal information, such as a mailing address, to fulfill the terms of this warranty. Any personal data will be handled pursuant to BISSELL's Privacy Policy, which can be found at global.BISSELL.com/privacy-policy.

Limited 2- or 3-Year Warranty (varies by model)

Model 3700E: Limited 2-Year Warranty

Model 3689E: Limited 3-Year Warranty

For two or three years from the date of purchase by the original purchaser, subject to the EXCEPTIONS AND EXCLUSIONS* identified below, BISSELL will repair or replace (with new, refurbished, lightly used, or remanufactured components or products), at BISSELL's option, free of charge, any defective or malfunctioning part or product.

BISSELL recommends that the original packaging and original proof of purchase with the date of purchase and country where purchased be kept for the duration of the warranty period in case you want to redeem the warranty during the warranty period. Keeping the original packaging will assist with any necessary re-packaging and transportation but is not a condition of the warranty.

If your product is replaced by BISSELL under this warranty, then the new item will benefit from the remainder of the term of this warranty (calculated from the date of the original purchase). The period of this warranty shall not be extended whether or not your product is repaired or replaced.

*Exceptions and Exclusions from the Terms of the Warranty

This warranty applies to products used for personal domestic use and not commercial or hire purposes. Consumable components and attachments such as filters, belts, shells, water tanks, scraping strips, brushes, and mop pads, which must be replaced or serviced by the user from time to time, are not covered by this warranty. This warranty does not apply to any defect arising from fair wear and tear, including but not limited to the battery discharging time shortening due to the aging or use. Damage or malfunction caused by the user or any third party whether as a result of accident, negligence, abuse, neglect, or any other use not in accordance with the user guide is not covered by this warranty. An unauthorised repair (or attempted repair) may void this warranty whether or not damage has been caused by that repair/attempt. Removing or tampering with the Product Rating Label on the product or rendering it illegible will void this warranty.

Except as set out below, BISSELL and its distributors are not liable for any loss or damage that is not foreseeable or for incidental or consequential damages of any nature associated with the use of this product including without limitation loss of profit, loss of business, business interruption, loss of opportunity, distress, inconvenience, or disappointment. Except as set out below, BISSELL's liability will not exceed the purchase price of the product.

BISSELL does not exclude or limit in any way its liability for (a) death or personal injury caused by our negligence or the negligence of our employees, agents or subcontractors; (b) fraud or fraudulent misrepresentation; (c) or for any other matter which cannot be excluded or limited under law.

Important Notes

- If your BISSELL product should require service or to claim under our limited warranty, please visit global.BISSELL.com.
- Please keep your original sales receipt. It provides proof of the date of purchase and where it was purchased in the event of a warranty claim. See warranty for details.
- Please note that using your BISSELL machine outside of its country of original purchase and/or use with a power converter may damage your BISSELL machine and damage caused by mismatched power voltage will not be covered by your warranty.
- Please note that putting vinegar, bleach, dish soap, detergent, homemade soap, and other non-BISSELL products in your BISSELL machine may damage your BISSELL machine. Damage caused by using non-BISSELL products in your machine will not be covered by your warranty.



- ተገቢ መስፈርቶችን ለማሟላት ለእርስዎ ለገደብ ስታገኙ።
- የደንበኞችን ለገደብ ለማሟላት ስለሚያስፈልግ ደንበኞች ለገደብ ለማሟላት ብቻ ለሚገኝ ገንዘብ ደረጃዎችን ማሟላት ይገባል።
- የገንዘብ ደረጃዎች ለማሟላት ስለሚያስፈልግ ደንበኞች ለገደብ ለማሟላት ብቻ ለሚገኝ ገንዘብ ደረጃዎችን ማሟላት ይገባል።
- የገንዘብ ደረጃዎች ለማሟላት ስለሚያስፈልግ ደንበኞች ለገደብ ለማሟላት ብቻ ለሚገኝ ገንዘብ ደረጃዎችን ማሟላት ይገባል።

የገንዘብ ደረጃዎች

የገንዘብ ደረጃዎች

የገንዘብ ደረጃዎችን ለማሟላት ለሚያስፈልግ ደንበኞች ለገደብ ለማሟላት ብቻ ለሚገኝ ገንዘብ ደረጃዎችን ማሟላት ይገባል።

የገንዘብ ደረጃዎችን ለማሟላት ስለሚያስፈልግ ደንበኞች ለገደብ ለማሟላት ብቻ ለሚገኝ ገንዘብ ደረጃዎችን ማሟላት ይገባል።

የገንዘብ ደረጃዎችን ለማሟላት ስለሚያስፈልግ ደንበኞች ለገደብ ለማሟላት ብቻ ለሚገኝ ገንዘብ ደረጃዎችን ማሟላት ይገባል።

የገንዘብ ደረጃዎች ለማሟላት

የገንዘብ ደረጃዎችን ለማሟላት ስለሚያስፈልግ ደንበኞች ለገደብ ለማሟላት ብቻ ለሚገኝ ገንዘብ ደረጃዎችን ማሟላት ይገባል።

36895 የገንዘብ ደረጃዎች ለማሟላት

30715 የገንዘብ ደረጃዎች ለማሟላት

የገንዘብ ደረጃዎች ለማሟላት

global.bissell.com/privacy-policy

የገንዘብ ደረጃዎችን ለማሟላት ስለሚያስፈልግ ደንበኞች ለገደብ ለማሟላት ብቻ ለሚገኝ ገንዘብ ደረጃዎችን ማሟላት ይገባል።

يتم إنتاج هذه المكنيات في الصين باستخدام مواد البلاستيك المعاد تدويره. يرجى إعادة تدويرها بشكل صحيح عند التخلص منها. يرجى الرجوع إلى دليل التعليمات للحصول على مزيد من المعلومات. يرجى تجنب استخدام هذه المكنيات على الأسطح الحساسة مثل البلاستيك.

✓			تحتفظ بإحدى يديك في كل مرة
✓			لا تتركها وتكون سهلة التنظيف والتعبئة
	✓		لتنظيف الجدران والأسطح
	✓	✓	لتنظيف المصباح والمواسير
	✓	✓	المسحوق المنظف
تحقق من إخراج الكهربي والأسلاك	الجدران والأسطح	الجدران والأسطح	الأسطح المصقولة
5" 3"	5" 5"	5" 5"	الأسطح المصقولة
للتنظيف الجدران والأسطح	للتنظيف الجدران والأسطح	للتنظيف الجدران والأسطح	للتنظيف الجدران والأسطح
الرش	الجدار	الجدار	الرش
وضع الفسج	وضع الجدار	وضع الجدار	وضع الفسج

Multi-Surface
أداة Multi-Surface
تتميز بـ 6 فتحات تنظيف متعددة على رأسها
وتستخدم لإزالة البقع من الأسطح المختلفة
مثل البلاستيك والبلاستيك والمواسير



Max Clean
أداة Max Clean
تتميز بـ 6 فتحات تنظيف متعددة على رأسها
وتستخدم لإزالة البقع من الأسطح المختلفة
مثل البلاستيك والبلاستيك والمواسير



3" 3"
أداة 3" 3"
تتميز بـ 6 فتحات تنظيف متعددة على رأسها
وتستخدم لإزالة البقع من الأسطح المختلفة
مثل البلاستيك والبلاستيك والمواسير



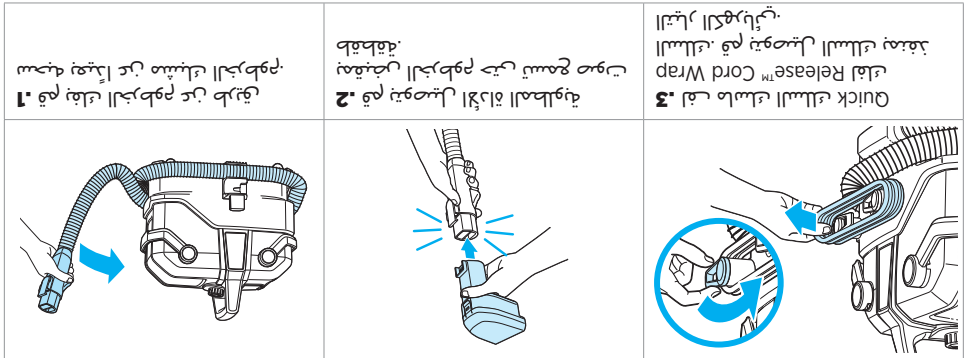
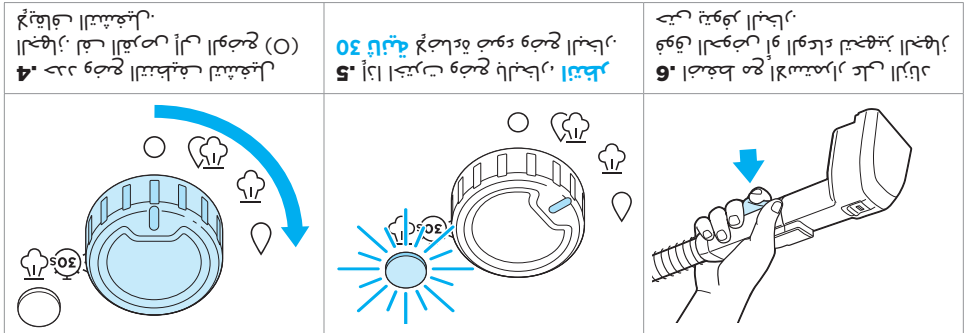
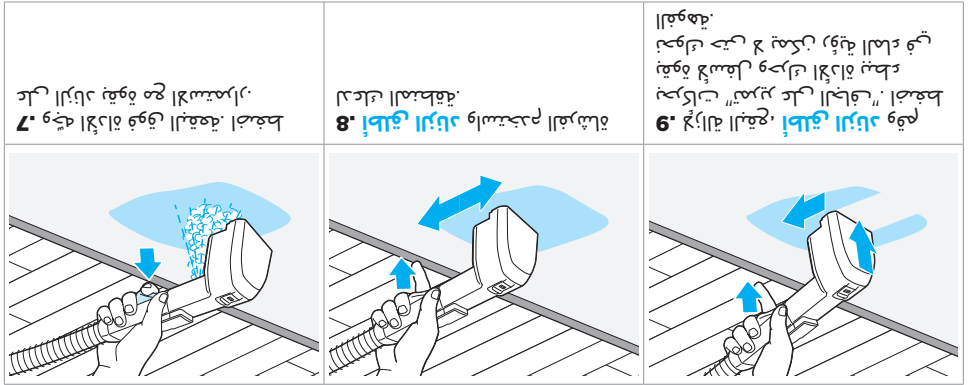

التي تخرجها من البخار في اتجاه الأرض. **الخطوة 6: قفازات البخار SteamWash™ Max Clean** وضوح البخار. **الخطوة 7:** في اتجاه الأرض. **الخطوة 8:** قفازات البخار في اتجاه الأرض. **الخطوة 9:** قفازات البخار في اتجاه الأرض. **الخطوة 10:** قفازات البخار في اتجاه الأرض.

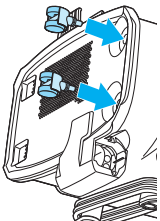
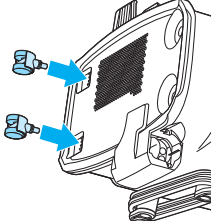

الخطوة 15: قفازات البخار في اتجاه الأرض. **الخطوة 16:** قفازات البخار في اتجاه الأرض. **الخطوة 17:** قفازات البخار في اتجاه الأرض. **الخطوة 18:** قفازات البخار في اتجاه الأرض. **الخطوة 19:** قفازات البخار في اتجاه الأرض. **الخطوة 20:** قفازات البخار في اتجاه الأرض.

<p> </p>	<p> </p>
	

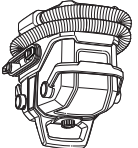

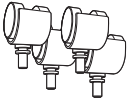











**||
||**

<p> </p>	<p> </p>	<p> </p>	<p> </p>
			

||
||
||
||
||
||
||

**||
||**

	ደ ጥራት ለማረጋገጥ የሚያስፈልጉት ምልክት።
	ጭታ
	09 ሰዓት ለማጠናቀቅ የሚያስፈልገው ሰዓት።
	የሥራ ስራ ለማድረግ የሚያስፈልጉት ምልክት።
	የሥራ ስራ ለማድረግ የሚያስፈልጉት ምልክት።
	የሥራ ስራ ለማድረግ የሚያስፈልጉት ምልክት።
	የሥራ ስራ ለማድረግ የሚያስፈልጉት ምልክት።
	የሥራ ስራ ለማድረግ የሚያስፈልጉት ምልክት።
	የሥራ ስራ ለማድረግ የሚያስፈልጉት ምልክት።
	የሥራ ስራ ለማድረግ የሚያስፈልጉት ምልክት።
	የሥራ ስራ ለማድረግ የሚያስፈልጉት ምልክት።
	የሥራ ስራ ለማድረግ የሚያስፈልጉት ምልክት።
	የሥራ ስራ ለማድረግ የሚያስፈልጉት ምልክት።
	የሥራ ስራ ለማድረግ የሚያስፈልጉት ምልክት።
	የሥራ ስራ ለማድረግ የሚያስፈልጉት ምልክት።
በሥራ	2 ሰዓት

	የሥራ ስራ ለማድረግ የሚያስፈልጉት ምልክት።
	የሥራ ስራ ለማድረግ የሚያስፈልጉት ምልክት።
	የሥራ ስራ ለማድረግ የሚያስፈልጉት ምልክት።
	የሥራ ስራ ለማድረግ የሚያስፈልጉት ምልክት።
	የሥራ ስራ ለማድረግ የሚያስፈልጉት ምልክት።
	የሥራ ስራ ለማድረግ የሚያስፈልጉት ምልክት።
	የሥራ ስራ ለማድረግ የሚያስፈልጉት ምልክት።
	የሥራ ስራ ለማድረግ የሚያስፈልጉት ምልክት።
	የሥራ ስራ ለማድረግ የሚያስፈልጉት ምልክት።
	የሥራ ስራ ለማድረግ የሚያስፈልጉት ምልክት።
	የሥራ ስራ ለማድረግ የሚያስፈልጉት ምልክት።
	የሥራ ስራ ለማድረግ የሚያስፈልጉት ምልክት።
	የሥራ ስራ ለማድረግ የሚያስፈልጉት ምልክት።
	የሥራ ስራ ለማድረግ የሚያስፈልጉት ምልክት።
በሥራ	2 ሰዓት

- 2.1. مفتاح وضع التشغيل والتبديل
 2.2. صوتية الجاهزة الجار
 3. جزان الماء النظف
 4. جزان الماء الفكر
 5. جاصبة سحب سلك التيار الكهربائي Quick Release™
 6. جزان مرن

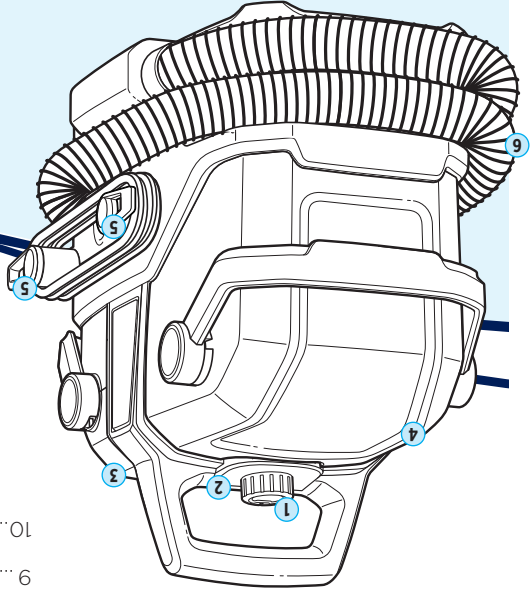

- 4 ما الذي يحتويه الصندوق؟
 4 التخفيف حسب الموديل (تخفيف الموديل)
 5 جزان مرن
 6 تنظيف السطح والجاهزة
 7 استخدام جزان
 8 أجزاء المتسخة
 8 تنظيف وحماية جزان التشغيل
 9 الأجزاء الحار
 9 المشغلات وطرق صلاحها
 10 جزان مرن

SPOTCLEAN® HYDROSTEAM™
 منظف السجاد والمفروشات المحمول
 36899E و 3700E موديل

BISSELL®

